

Z⁺600 Series

IEC 61000

DATA

DWG. No. IA712-58-01		
APPD	CHK	DWG
<i>J</i> 11/3/13	<i>J</i> 11/3/13	<i>Cyanic</i> 10/03/13

INDEX	PAGE
1. Electrostatic Discharge Immunity Test (IEC61000-4-2)	R-1
2. Radiated Radio-Frequency Electromagnetic Field Immunity Test (IEC61000-4-3)	R-2
3. Electrical Fast Transient / Burst Immunity Test (IEC61000-4-4)	R-3
4. Surge Immunity Test (IEC61000-4-5)	R-4
5. Conducted Disturbances Induced by Radio-Frequency Field Immunity Test (IEC61000-4-6)	R-5
6. Power Frequency Magnetic Field Immunity Test (IEC61000-4-8)	R-6
7. Voltage Dips, Short Interruptions Immunity Test (IEC61000-4-11)	R-7
8. Input Current Harmonics Test (IEC61000-3-2)	R-8

* Test results are typical data. Nevertheless the following results are considered to be actual capability data because all units have nearly the same characteristics.

1. Electrostatic Discharge Immunity Test (IEC61000-4-2)

(1) Equipment used

Electrostatic discharge simulator: ESS-2000 (NOISEKEN)

Discharge resistance: 330Ω Capacitor: 150pF

(2) Test conditions

Input voltage: 115,230Vac Output voltage: 100%

Output current: 100% Polarity: -,+

Number of tests: 10 times Ta: 25°C

Discharge interval: >1 Second

(3) Test method and Device test point

Contact discharge: FG, Case screw

Air discharge: Input and Output terminal

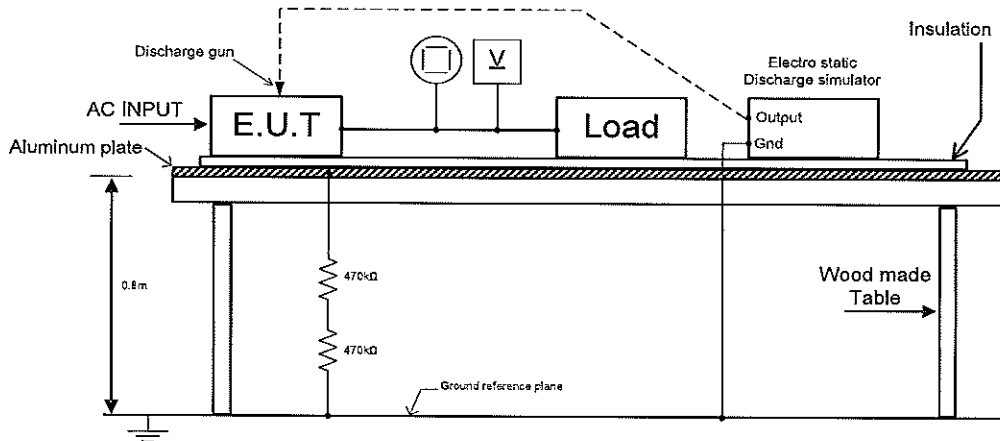

(4) Acceptable conditions

1. Output voltage regulation not to exceed ± 5% of initial (before test) value during test.
2. Output voltage to be within regulation specification after the test.
3. Along with 1 and 2, no discharge of fire or smoke, as well as no output failure.

(5) Test Result

Contact Discharge (KV)	Z36-18	Air Discharge (KV)	Z36-18
4	PASS	8	PASS

2. Radiated Radio-Frequency Electromagnetic Field Immunity Test (IEC61000-4-3)

(1) Equipment used

Test Laboratory: Hermon Laboratories Ltd.

(2) Test conditions

Input voltage: 115,230Vac

Output voltage: 100%

Output current: 100%

Amplitude Modulated: 80%,1kHz

Electromagnetic Frequency: 80~1000MHz

Ambient temperature: 25°C

Distance: 2.4m

Wave Angel: Horizontal and Vertical

Sweep condition: 1.0% Step Up, 2.8 second Hold

Test Angle: Top/Bottom, Both Sides, Front/Back

(3) Test Method:

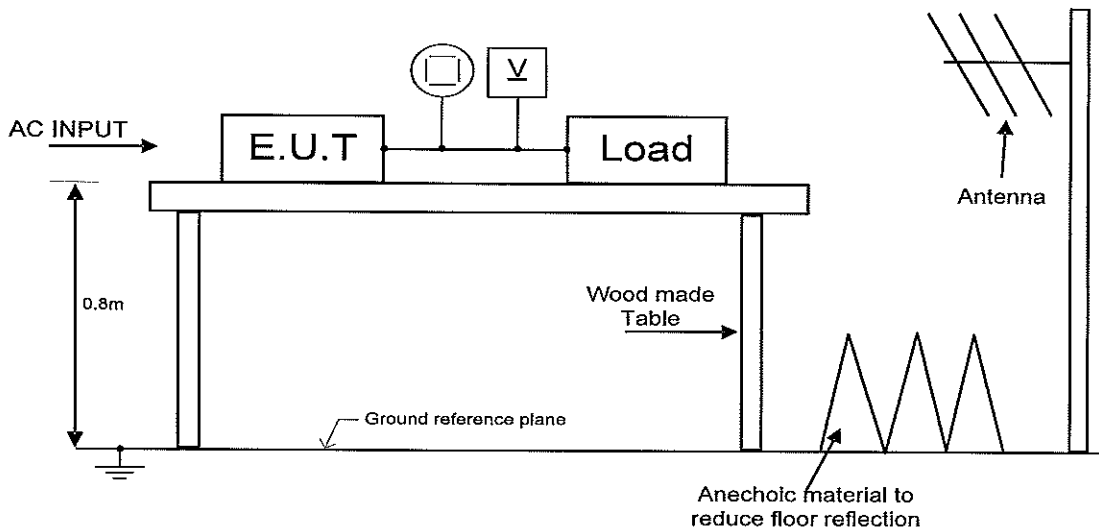

(4) Acceptable conditions

1. Output voltage regulation not to exceed $\pm 5\%$ of initial (before test) value during test.
2. Output voltage to be within regulation specification after the test.
3. Along with 1 and 2, no discharge of fire or smoke, as well as no output failure.

(5) Test Result

Radiated Field Strength (V/m)	Z36-18
3	PASS

3. Electrical Fast Transient / Burst Immunity Test (IEC61000-4-4)

(1) Equipment used

EFT/B Generator: SCHAFFNER NSG2025

(2) Test conditions

Input voltage: 115,230Vac

Output voltage: 100%

Output current: 100%

Test time: 1 minute

Polarity: -,+

Ambient temperature: 25°C

Number of tests: 3 times

(3) Test method and Device test point

Neutral (N), Line (L), Ground (FG) apply pulses from EFT/B Generator to N, L, FG separately, as well as, all at the same time.

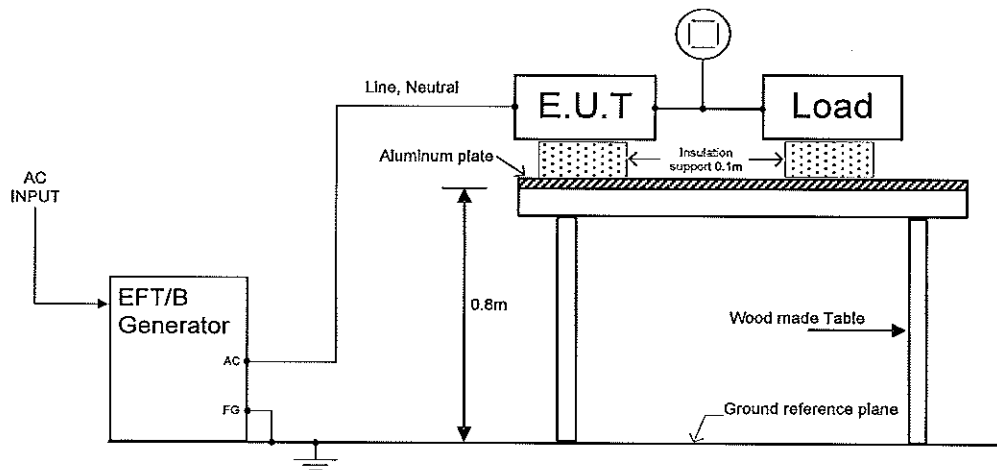

(4) Acceptable conditions

1. Output voltage regulation not to exceed $\pm 5\%$ of initial (before test) value during test.
2. Output voltage to be within regulation specification after the test.
3. Along with 1 and 2, no discharge of fire or smoke, as well as no output failure.

(5) Test Result

Test Voltage (kV)	Repetition Rate (kHz)	Z36-18
2	5	PASS

4. Surge Immunity Test (IEC61000-4-5)

(1) Equipment used

Surge Generator: NSG651 (SCHAFFNER)

Coupling impedance: Common - 12Ω Normal - 2Ω

Coupling capacitance: Common - 9 uF Normal - 18 uF

Coupling network: CDN110 (SCHAFFNER)

(2) Test method and device test point

Input voltage: 115,230Vac

Output voltage: 100%

Output current: 100%

Number of tests: 5 times

Polarity: -,+

Ambient temperature: 25°C

Phase: 0°, 90°

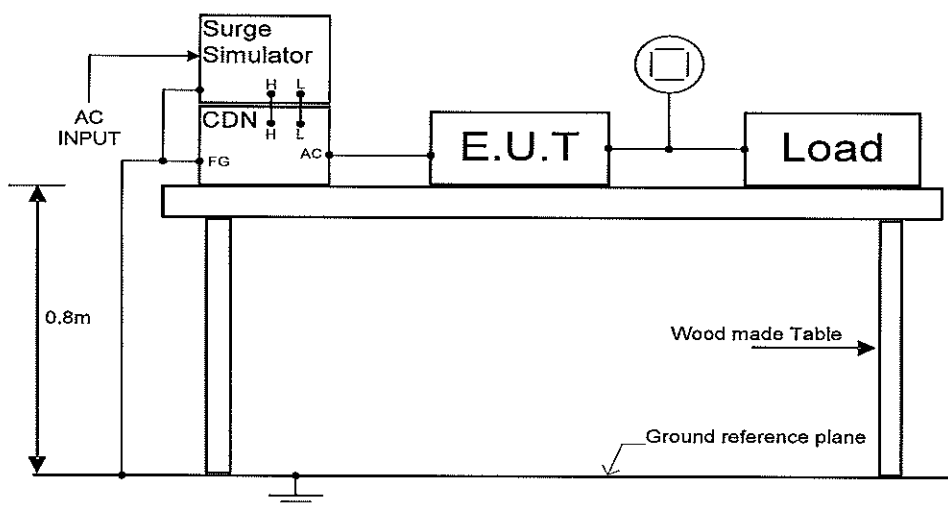

(3) Acceptable conditions

1. Output voltage regulation not to exceed ± 5% of initial (before test) value during test.
2. Output voltage to be within regulation specification after the test.
3. Along with 1 and 2, no discharge of fire or smoke, as well as no output failure.

(4) Test Result

Test Voltage (kV) Common	Z36-18	Test Voltage (kV) Normal	Z36-18
1.0	PASS	1.0	PASS
2.0	PASS		

5. Conducted Disturbances Induced by Radio-Frequency Field Immunity Test (IEC61000-4-6)

(1) Equipment used

RF Signal Generator 10kHz-1050MHz:	Fluke,6061A
RF Amplifier 10kHz-220MHz,150W:	Amplifier Research,150L
Coupling/Decoupling Network:	HL CDN 801-M3

(2) Test Condition:

Output voltage: 100%	Electromagnetic Frequency: 150kHz~80MHz
Input voltage: 115,230Vac	Type of modulation: AM 80% @ 1khz
Output current: 100%	Test Voltage: 3V _{rms} prior to modulation
	Dwell Time: 3s
	Frequency Step: 1.0% of current frequency

Ambient temperature: 25°C

(3) Test Method:

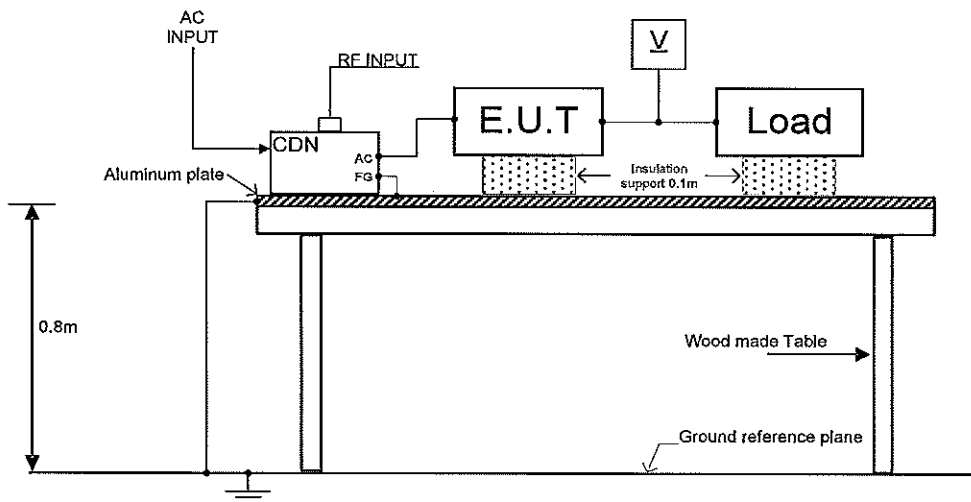

(4) Acceptable conditions

1. Output voltage regulation not to exceed ± 5% of initial (before test) value during test.
2. Output voltage to be within regulation specification after the test.
3. Along with 1 and 2, no discharge of fire or smoke, as well as no output failure.

(5) Test Result

Test Voltage Level (V)	Z36-18
3	PASS

6. Power Frequency Magnetic Field Immunity Test (IEC61000-4-8)

(1) Equipment used

Test Laboratory: Hermon Laboratories Ltd.

(2) Test Condition:

Input voltage: 115,230Vac

Output voltage: 100%

Output current: 100%

Frequency: 50Hz

Magnetic Field Strength: 30A/m

Direction: X, Y, Z

Duration Time: 10min.

Ambient temperature: 25°C

(3) Test Method:

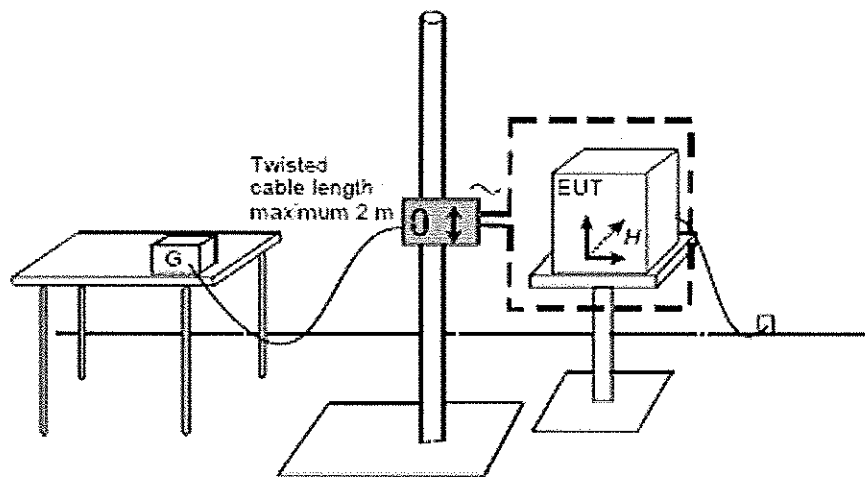

(4) Acceptable conditions

1. Output voltage regulation not to exceed $\pm 5\%$ of initial (before test) value during test.
2. Output voltage to be within regulation specification after the test.
3. Along with 1 and 2, no discharge of fire or smoke, as well as no output failure.

(5) Test Result

EUT positions	Result
X	PASS
Y	PASS
Z	PASS

7. Voltage Dips, Short Interruptions Immunity Test (IEC61000-4-11)

(1) Equipment used

AC Source: 6590 (CHROMA)

Oscilloscope: DL1740EL (Yokogawa)

(2) Test Condition:

Input voltage: 115,230Vac

Output voltage: 100%

Output current: 100%

Frequency: 50Hz

Repetition: 0.1Hz

Ambient temperature: 25°C

Number of tests: 3 times

(3) Test Method:

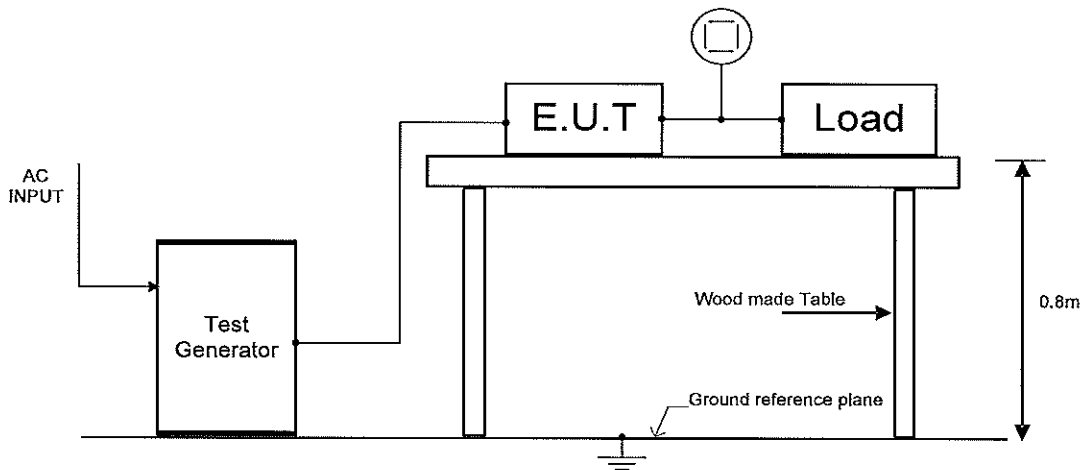

(4) Acceptable conditions

1. Output voltage to be within output voltage regulation specification after the test.
2. No discharge of fire or smoke, as well as no output failure.

(5) Test Result

Test level	Dip rate	Continue time ts	Result
70%	30%	500ms	PASS
40%	60%	200ms	PASS
0%	100%	5000ms	PASS

8. Input Current Harmonics Test (IEC61000-3-2)

(1) Equipment used

AC Power Analyzer: WT110 (Yokogawa)

AC Source: 6590 (CHROMA)

(2) Test conditions:

Input voltage: 115, 230Vac Output current: 100%

Output Voltage: 100%

(3) Test Method:

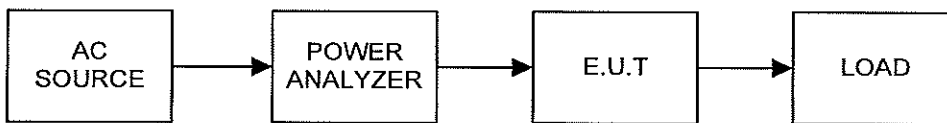

Vin: 115Vac

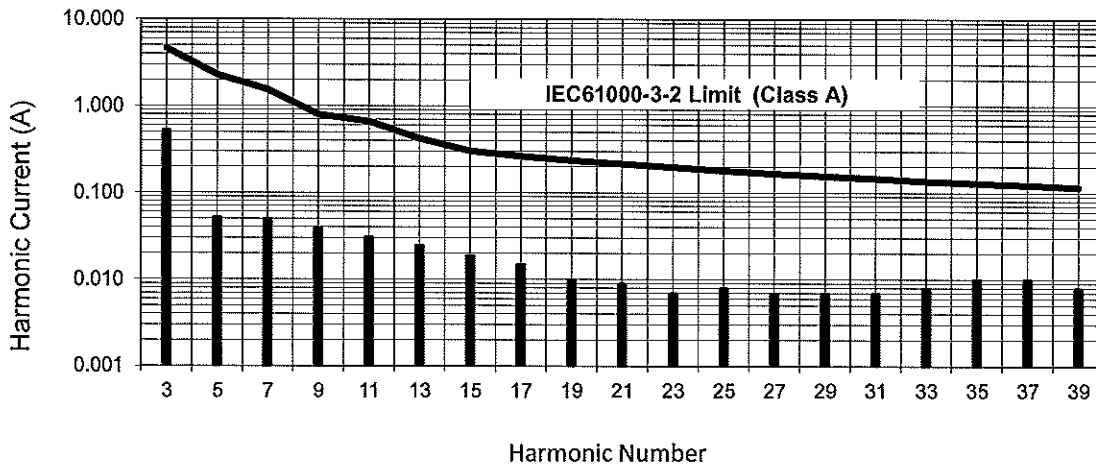

Vin: 230Vac

